



Corner Refrigerated and Dry Display Case

KBF-60C | KBF-60CD



KBF-60C

Durable Design

- Forced air, self-contained refrigerated merchandiser (for the refrigerated cases only)
- Modern design for merchandising beverages, cheese, sandwiches and much more
- Exterior and interior tempered safety glasses
- 1 single sliding glass doors
- Designed for mobility, reliability & efficiency in commercial kitchens
- (2) Height Adjustable shelves
- Slide out condensing unit for easy maintenance
- Five (5) casters with 2 brakes
- Simple plug-in installation

Superior Quality

- Stainless steel lower body panels
- Solid body construction
- Certified to ETL safety and sanitation standards
- With R290 refrigerant

Energy Efficient

- Digital temperature readout display with electronic thermostatic control
- Double layer glass for front and sides and back (there is NO film heaters inside of the glass)
- LED lighting at top & under shelves & on base back and front
- Automatic defrost system
- Case holds 36°F - 41°F



Introducing the Kool-It KBF Corner Refrigerated and Dry Display Cases, where modern design meets functionality to elevate your merchandising experience. Whether you're showcasing chilled beverages, tempting desserts, savory sandwiches, or any other delicacies, the Kool-It KBF Corner Refrigerated and Dry Display Cases is the ultimate solution for stylish merchandising.



Warranty: 12 months parts and labor. *Additional 48 months on compressor (part only)
KOOL-IT is a registered trademark of MVP Group. Specifications subject to change without notice.
The refrigerated KBF series cases are engineered to operate in locations not exceeding 80°F and 55%

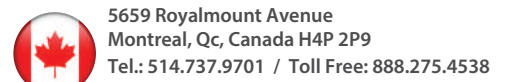
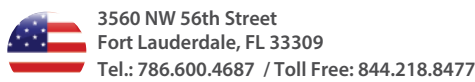

sales@mvpgroupcorp.com



Corner Refrigerated and Dry Display Case

KBF-60 | KBF-60CD

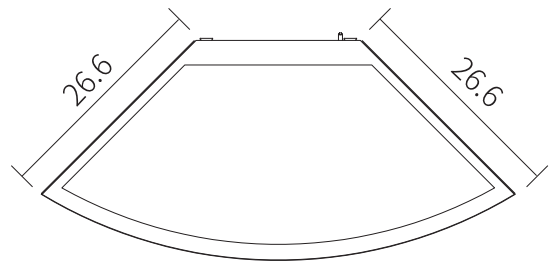
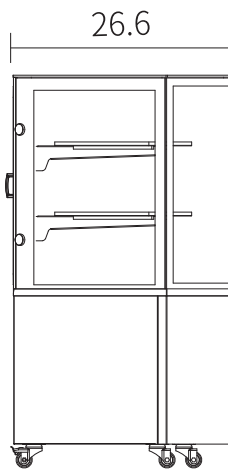
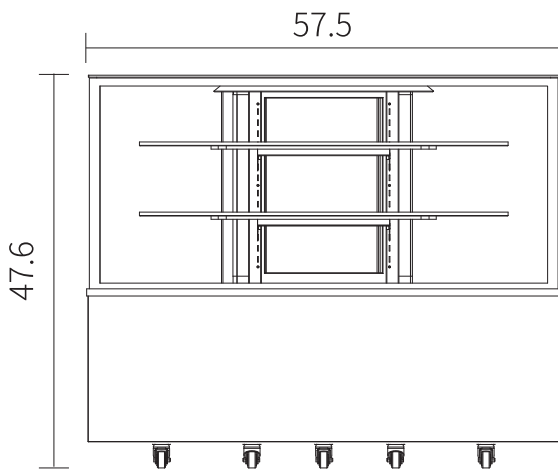
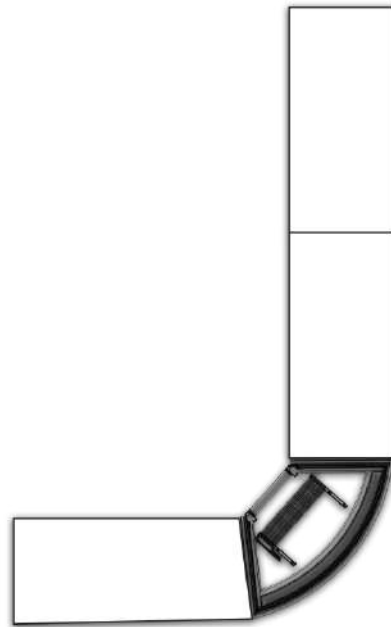
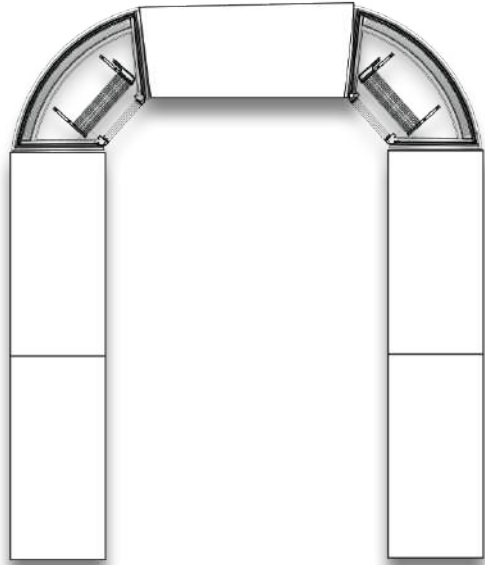

MODEL	CAPACITY (Cubic feet)	VOLTAGE	AMPS	COMPRESSOR	EXTERNAL DIMENSIONS (W x D x H)	SHIPPING DIMENSIONS (W x D x H)	SHIP WEIGHT (LBS)
KBF-60C	12.36	110-120/60/1	7	1/3	57.5"x26.6"x47.6"	62.0" x 31.9" x 55.5"	498
KBF-60CD	12.36	110-120/60/1	0.8	N/A	57.5"x26.6"x47.6"	62.0" x 31.9" x 55.5"	432



www.mvpgroupcorp.com



3560 NW 56th Street
Fort Lauderdale, FL 33309
Tel.: 786.600.4687 / Toll Free: 844.218.8477



5659 Royalmount Avenue
Montreal, Qc, Canada H4P 2P9
Tel.: 514.737.9701 / Toll Free: 888.275.4538

sales@mvpgroupcorp.com