

REFRIGERATOR MANUFACTURER
Turbo air
 more durable, efficient, beautiful

4184 E. Conant St.
 Long Beach, CA 90808
 Tel. 310-900-1000
 Fax. 310-900-1077
www.turboairinc.com

Project :	
Model # :	
Item # :	Qty :
Available W/H :	
Approval :	

Pass Thru Half Solid Door Heated Cabinet

Pass-Thru
PRO Series

FEATURES & BENEFITS

Model : PRO-26-2H-PT(-L)
PRO-26-2H2-PT(-L)

- **Digital temperature control & monitor system**
 - Keep food products safe by maintaining constant temperatures.
 - Alarm beeps when doors are not sealed.
 - Early warning alarm program detects issues before malfunction occurs.
 - Digital display allows for easy monitoring.
 - Sensitive touch display.
- **Ducted fan air distribution system**
 Maintains temperature within the food zone
- **On/Off switch**
 ON/OFF switch is located on control panel
- **All stainless steel cabinet construction**
 The PRO series model boasts a stainless steel interior and a **22 gauge** stainless steel exterior (galvanized steel top, bottom). It guarantees the utmost in cleanliness and long product life. The PRO series model adds a touch of style to the most refined setting.
- **Sturdy, clean stainless steel shelving**
 Shelves are the most important part of cleanliness as they come in direct contact with food. After a while, PVC coated wire shelves may peel, rust and lead to unsanitary conditions. Only the Turbo Air PRO series uniquely provides stainless steel shelving.
- **LED interior lighting**
- **High-density polyurethane insulation**
 The entire cabinet structure and solid doors are foamed-in-place using high density, CFC free polyurethane insulation.
- **Half length stainless steel solid doors with locks**
- **Self-closing doors with stay open feature at 120 degrees**
- **Heated cabinet holds 140°F ~ 180°F for the best in food preservation**
- **Lifetime guaranteed heavy duty hinges and handles**
 - PRO-26-2H-PT: Right hinged, 115V
 - PRO-26-2H-PT-L: Left hinged, 115V
 - PRO-26-2H2-PT: Right hinged, 208V
 - PRO-26-2H2-PT-L: Left hinged, 208V



Model	Swing Door	CU./FT.	#of Shelves	Wattage (W)	AMPS	Crated Weight (lbs.)	L x D x H [†] (inches)
PRO-26-2H-PT(-L) PRO-26-2H2-PT(-L)	4	26.2	3	1550	13.5 7.5	310	28 ³ / ₄ X 36 ¹ / ₄ X 78

Pass Thru Half Solid Door Heated Cabinet

Pass-Thru
PRO Series

Model : PRO-26-2H-PT(-L) PRO-26-2H2-PT(-L)

ELECTRICAL DATA	PRO-26-2H-PT(-L)	PRO-26-2H2-PT(-L)
Voltage	115/60/1	208/115/60/1
Plug Type	Ⓜ NEMA 5-15P	Ⓜ NEMA L14-20P
Full Load Amperes	13.5	7.5
Wattage (W)	1550	1550
Feed Wires with Ground	3	4
Cord Length (ft.)	8	8
DIMENSIONAL DATA		
# of Doors	4	4
# of Racks Accepted	1	1
Net Capacity (cu. ft.)	26.2	26.2
Ext. Length Overall (in.)	28 ³ / ₄ (730mm)	28 ³ / ₄ (730mm)
Ext. Depth Overall (in.) [*]	36 ¹ / ₄ (920mm)	36 ¹ / ₄ (920mm)
Ext. Height Overall (in.) [†]	78 (1982mm)	78 (1982mm)
Int. Length Overall (in.)	22 (559mm)	22 (559mm)
Int. Depth Overall (in.)	27 ⁵ / ₈ (702mm)	27 ⁵ / ₈ (702mm)
Int. Height Overall (in.)	58 ³ / ₄ (1493mm)	58 ³ / ₄ (1493mm)
# of Shelves	3	3
Shelf Size (L x D) (in.)	23 ¹ / ₂ x 26 ³ / ₈	23 ¹ / ₂ x 26 ³ / ₈
Net Weight (lbs.)	265	265
Gross Weight (lbs.)	310	310

Design and specifications subject to change without notice.

Actual shipping weight may differ due to extra packing materials for product protection.

* Depth does not include 2-1/2" for door handles.

† Height does not include 5" for caster height.

■ WARRANTY : 3 Year Parts and Labor Warranty

■ STANDARD FEATURES

- Door locks standard
- Standard 4" dia. swivel casters with locks on the front set
- Easy replaceable one piece magnetic door gaskets
- Solid and sturdy grille design

■ OPTIONAL ACCESSORIES

- 5" caster, 1/2" diameter & 13 TPI:
M726500100 (non-brake), M726500200 (w/ brake)
- 4.7" leveling seismic leg (1/2", 13 TPI): 30221M0500
- 6" stainless steel leg: 30221M0600
- Additional stainless steel shelf: H26R901680
- Half door bun tray rack: TSP-2224
(each holds up to six 18"L x 26"D sheet pans-sold separately)
- Tray slides kits: TS1-N1(#1), TS1-N4(#4), TS1-UN(Universal)

PLAN VIEW

(unit : inch)

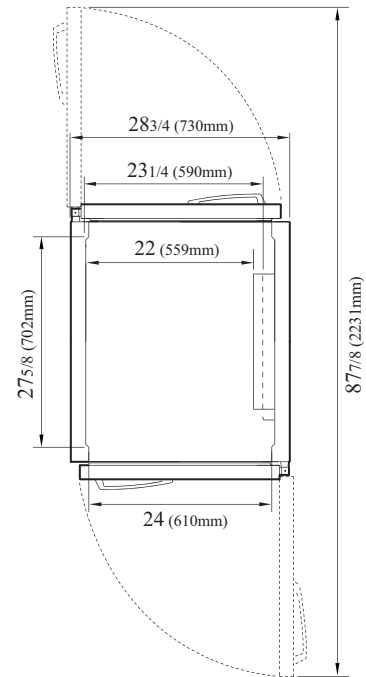

TOP VIEW

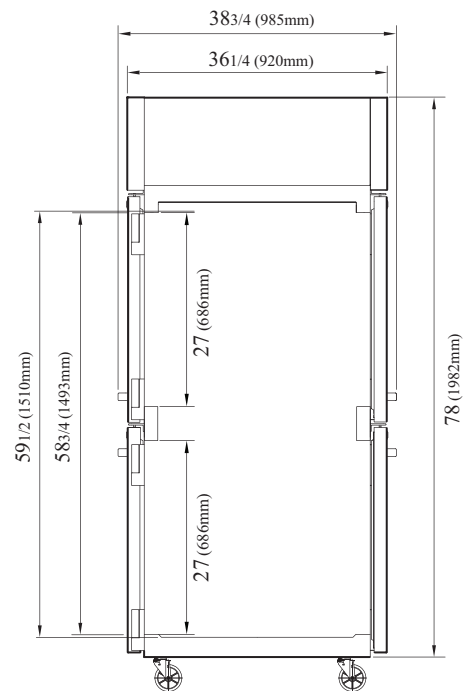

SIDE VIEW

Ver.20191118



- Turbo Air : 800-627-0032
- GK : 800-500-3519
- Warranty : 800-381-7770
- AC : 888-900-1002

REFRIGERATION MANUFACTURER
Turbo air

GERMAN
KNIFE

IRADIANCE

REFRIGERATION SYSTEM
Turbo air **Texaking**