

marchia

USER MANUAL

OPEN AIR COOLER GRAB AND GO REFRIGERATOR



MODEL: MDS72



USR Brands, Inc.

Phone: 800-764-1172 | www.usrestaurant.com | sales@usrestaurant.com

Circuit Diagram

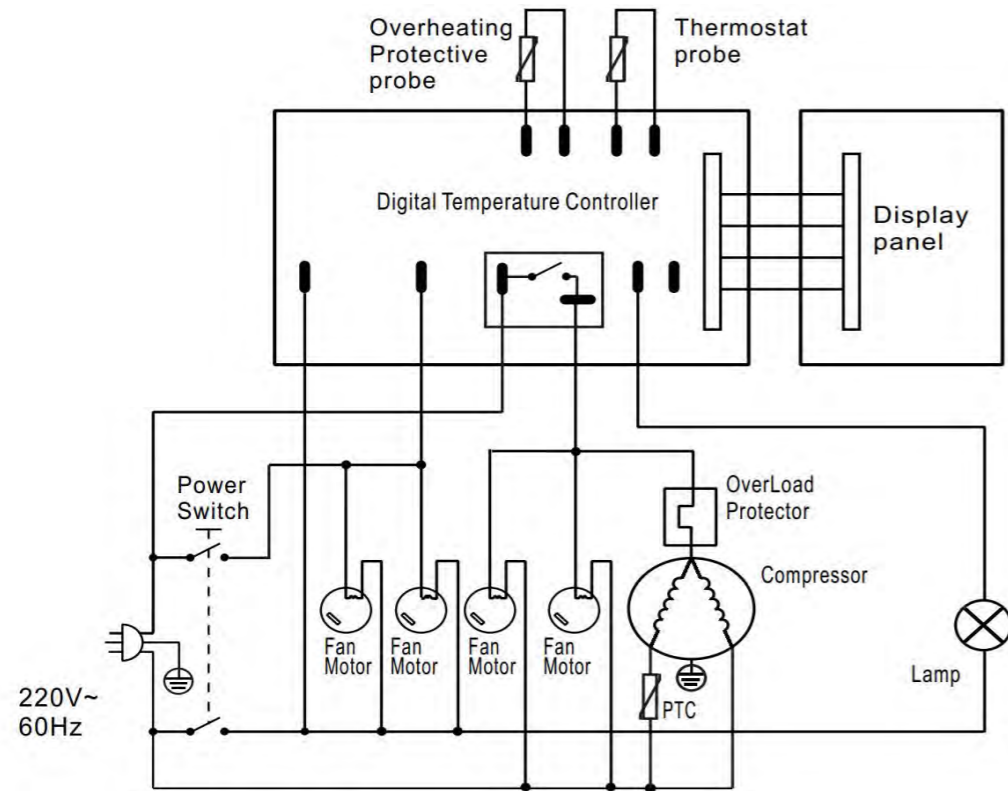

Note

1. The electric circuit diagram and parameters on the product name plate are final ones if they have been changed.
2. The design might be improved without notice.
3. If the supply cord is damaged, it must be replaced by the manufacturer, its service agent or similarly qualified persons in order to avoid a hazard.



Meaning of crossed out wheeled dustbin:

Do not dispose of electrical appliances as unsorted municipal waste, use separate collection facilities.

Contact your local government for information regarding the collection systems available.

If electrical appliances are disposed of in landfills or dumps, hazardous substances can leak into the groundwater and get into the food chain, damaging your health and well-being.

When replacing old appliances with new ones, the retailer is legally obligated to take back your old appliance for disposals at least free of charge.

Note

Following phenomena are not troubles:

The murmur of water is heard when the refrigerator is working. It is a normal phenomenon as the coolant is circulating in the system.

In wet season, condensation might be found on the outside of the refrigerator. It is not a trouble, which is caused by high humidity. Simply use cloth to wipe it.

Principle of Refrigeration System

The principle of compression refrigeration consists of "compression", "condensation", "throttling" and "vaporization". The compression is undertaken by compressor, the condensation is completed by condenser, the throttling is executed by capillary and the vaporization is implemented by evaporator. When the coolant is circulating in the closed refrigeration system, the compressor sucks coolant, which has absorbed heat in evaporator, the coolant becomes a high pressure and high temperature gas. In condenser, it dissipates heat in air, while the coolant is re-liquefied and throttled in capillary and then enters into evaporator with low pressure. The liquefied coolant quickly boils and vaporizes into gas when the pressure suddenly drops. Meanwhile, it absorbs heat inside the refrigerator. And the compressor sucks the low pressure and low temperature gaseous coolant,.....It is circulating in this way up to realization of intended refrigeration.

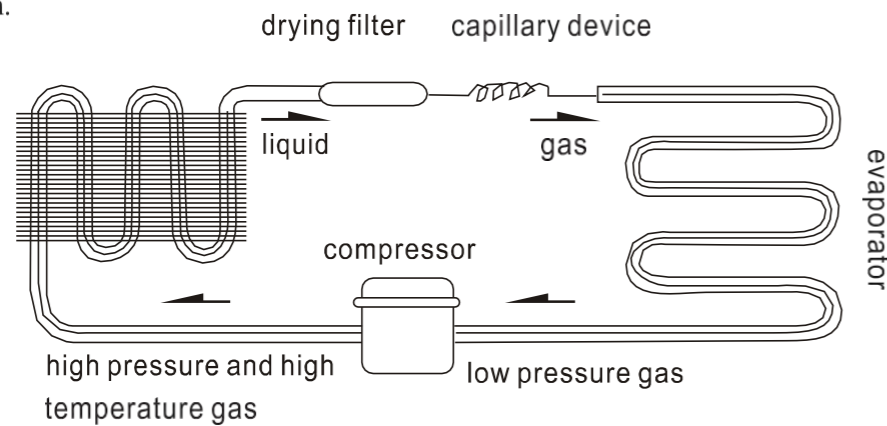

General



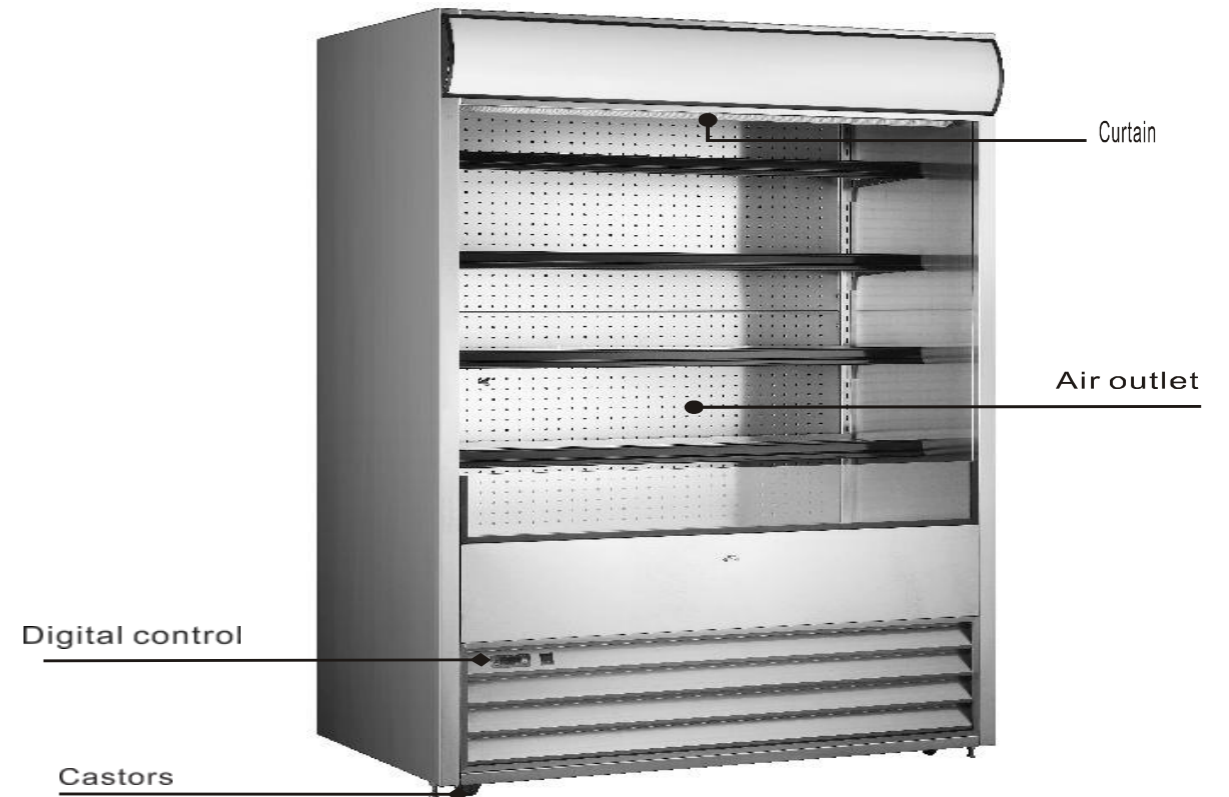

This product is a type of chilling cabinet, which is our new development of refrigeration combining the advanced technologies from both home and abroad on the basis of food cabinet standards and corporate criteria. Its main kits and key components are all good brands, either and streamlined design, the product integrates the actual market demand in structural design, which better cater to the ergonomics requirements of consumers.

This series applies mainly to displaying and selling of drinks, dairy products, vegetables and fruits.

Structure and Parts

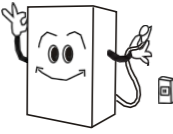

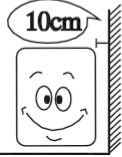
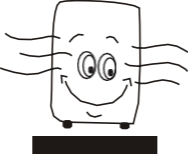
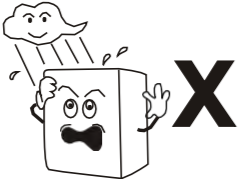
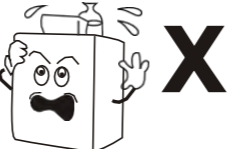
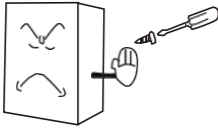
Handle and Erection

<p>Handle with care Unplug the wall socket first. Never tilt it over 45 degree during handling.</p> 	<p>Dry place Always locate the refrigerator at a dry place.</p> 
<p>Sufficient space The distance from both sides and back of refrigerator to wall or other substance must not less than 10cm. The refrigeration capability might be decreased if its surround space is too small to circulate air.</p> 	<p>Well ventilation Always locate the refrigerator at a place with fine ventilation. For the first time use, wait for 2 hours after handling and then plug the wall socket and start it.</p> 
<p>Far from heat source Never place the refrigerator directly under the sunshine. Never locate it nearby any heat source or heater to prevent it from reducing refrigeration capability.</p> 	<p>No heavy load Never put any heavy load on the top of the refrigerator.</p> 
<p>No hole making Never make hole on the refrigerator. Never install other matter on the refrigerator.</p> 	<p>Stable location To avoid the unexpected noise and vibration, Unpacking and locate the refrigerator on a flat and solid place.</p> 

Maintenance

- Cabinet cleaning.** The product should be cleaned once a week with power supply disconnected. In cleaning please use mild rinsing water or non-corrosive cleanser essence. Do not wash it directly with water faucet
- De-dusting for condenser.** The condenser should be cleaned every Three months with power supply disconnected. To clean the condenser, at the bottom panel for air suction, and remove the dust on the cooling fin of the condenser with wire brush or high pressure air gun.
- Leaking check.** Observe all connectors and welding joints for oil stain, which indicates a must for patching measures or call for professionals.
- Frequently observe the operation of the product.** Lu case of any abnormal noise, smell or smog, cut off the power supply immediately and call for professionals for help. Do not restart the product before trouble is cleared.
- We will not be responsible for any accident incurred by failures of following the notices.**
- Condensation water drainage:**
Please make sure the water pipe is unobstructed and its location lower than the joint to upper water receiver.

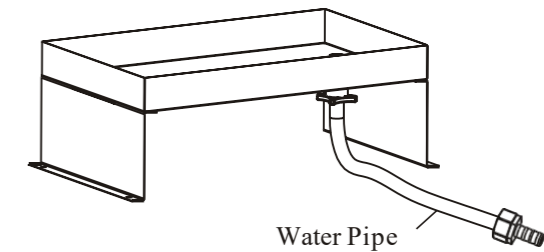

Trouble Shooting

Number	Troubles	Causes	Solutions
1	Strange noise under the bottom shelf	Fan blade broken.	Power off and fix the blade.
2	Non-refrigerating in spite of normal operation	1. Unit off. 2. Melting process 3. Refrigerant leaking 4. Unit failure.	1. Power on. 2. Stop melting. 3. Patch the leak and refill refrigerant 4. Call for professionals.
3	Weak air from air curtain, and higher cabinet temperature	1. Evaporator blocked by frost.. 2. Inside fan damaged. 3. Too low set point of temperature controller. 4. Vent blocked by storage	1. Increase melting frequency. 2. Replace the fan. 3. Adjust the set point. 4. Remove the storage.
4	Normal air curtain, but higher cabinet temperature	1. Insufficient refrigerant. 2. Too high set point of temperature controllers. 3. The wind curtain disturbed by strong air flow. 4. Ambient temperature or humidity beyond standards.	1. Refill the refrigerant. 2. Adjust the set point for the temperature controller. 3. Removing the disturbing factors. 4. Improve the conditions.
5	Melting water overflown	1. Heating pipe for melting water damaged 2. Water-level controller failure. 3. Ambient temperature or humidity beyond standards.	1. Replace the heating pipe. 2. Replace the water-level controller. 3. Improve the conditions.
6	Normal air curtain, but Periodical fluctuation of cabinet temperature	1. Condenser contaminated. 2. Poor venting of the unit. 3. Heat protection of compressor failure 4. Capillary is blocked by ice 5. Temperature controller failure.	1. Clean the condenser. 2. Improve the venting conditions. 3. Replace the heat protection. 4. Replace the drying filter. 5. Replace the temperature controller

2.8.3 In the internal parameter setting state, the character code is displayed in the temperature area. Press “▲” or “▼” to enter the specific parameter value, modify and display the set value, and press “SET” to confirm and enter the next operation.

2.8.4 If no key is pressed within 10 seconds, it will exit the internal setting state, and the internal parameters will be saved in the battery-free memory.

2.9 Defrosting control

2.9.1 Defrosting conditions: defrosting temperature probe is set according to F3 temperature and F2 defrosting interval period.

2.9.2 Temperature display during defrosting: F4=0 shows the normal temperature, F4=1 shows the temperature at the beginning of defrosting until the end of defrosting function; When defrosting, the “point icon” under “❄” is always on.

2.9.3 If there is no defrosting probe or the defrosting probe is abnormal, run according to F2 defrosting interval.

2.10 Instruction of condensate evaporation

2.10.1 When the condensate level reaches the full water level, start the evaporation heating pipe; If it is detected that the water level reaches the low water level, the evaporation heating pipe will stop working.

2.11 Compressor working status in case of abnormal temperature probe

2.11.1 If the temperature probe is abnormal, the fault code will display “EE1”. At this time, the compressor operates in the mode of opening 45MIN and stopping 15MIN until the temperature probe returns to normal display.

2.12 Compressor high temperature protection instruction

2.12.1 When the compressor temperature is higher than or equal to 60 °C, the compressor will produce protection action and stop working. When the compressor temperature is less than or equal to 48 °C, the compressor will work again.

2.13 Fault code description

Fault code	Reason explanation
EE1	Open circuit or short circuit of temperature probe
EE2	Open circuit or short circuit of defrosting probe
EE3	Open circuit or short circuit of compressor protection probe
EE4	The temperature of compressor protection probe is higher than 60 °C

3. Cautions

If the supply cord is damaged, it must be replaced by the manufacturer, its service agent or similarly qualified persons in order to avoid a hazard.

Do not store explosive substances such as aerosol cans with a flammable propellant in this appliance. Never block the air suction and outlet. Keep air circulation and refrigeration capability.

Do not make food congested as it will influence the cooling effect. Adjust the rack height for proper food storage.

Cool the hot food down to room temperature before you put it into the refrigerator.

Try to pull down the curtain and keep refrigerator inside cold in case the power is cut off.

Never touch compressor to avoid from scald.

Do not store explosive substances such as aerosol cans with a flammable propellant in this appliance.

During normal operation, the emission noise level does not exceed 70dB(A).

The maximum loading of the Shelf does not exceed 18kg.

The climatic class of the appliance is 3, the Units are suggested to be used at 16°C-25°C ambient temperature.

To avoid damages or other problems, this product can not be put or stored with any corrosive food.

Preparation and Power Supply

Exclusive power socket

Normally, the power supply should be 220V, 60Hz single phase AC with exclusive single phase three pin receptacle (250V, 10A) and fuse (6A). The power receptacle must have a reliable earth connection.

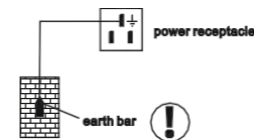

No share on socket

Never let the refrigerator share the common socket with other appliance, otherwise the cable becomes hot and fire might be resulted

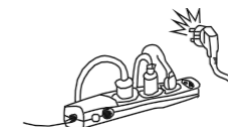

Protect cables

Never break or damage the cables otherwise current leakage and fire might be resulted.

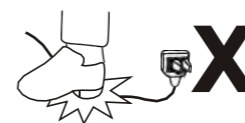

No water flushing

Never give the refrigerator surface a flush otherwise current leakage might be resulted.



Prevent from flammables and explosive

Never put any flammable or explosive inside the refrigerator such as ether, gasoline, alcohol, adhesive and explosive. Never put dangerous product nearby the refrigerator.

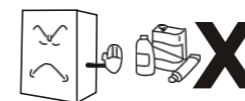

No spray

To spray the flammables such as paint or coating nearby the refrigerator is not allowed, otherwise fire might be resulted.



After power break

After power break or unplugging the refrigerator, always wait at least 5 minutes and then you may plug the refrigerator and start it again.



No medicine

No medicine is allowed to keep inside the refrigerator.



Use and Caution

1. Before use:

Plug the refrigerator on 220 V~ exclusive socket.

After the refrigerator running, put hand on the air suction to confirm it is sufficient cold. Then you may put food inside the cold box.

This appliance is not intended for use by persons (including children) with reduced physical, sensory or mental capabilities, or lack of experience and knowledge, unless they have been given supervision or instruction concerning use of the appliance by a person responsible for their safety. Children should be supervised to ensure that they do not play with the appliance.

The operation manual are not suitable for the persons (including children) with reduced physical, sensory or mental capabilities, or lack of experience and knowledge.

2. Digital Temperature controller:

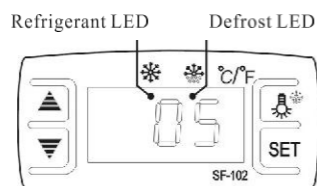

Features Of Function

- It is a mini-sized and integrated intelligent controller and applicable to the compressor of one Hp.
- The main functions are: Temperature Display/ Temperature control/Manual, automatic defrost by burning off/Illumination Control/Value Storing/self Testing/parameter Locking.

2.1 Icon instruction

2.1.1 “❄️” -defrost icon, “.” constant brightness indicates defrosting is in progress.

2.1.2 “❄️” -compressor icon, “.” flashing indicates compressor stop, and constant light indicates compressor is working.

2.2 Key instruction

2.2.1 “⏴” :short press to adjust the temperature value / long press to lock / unlock the internal parameters.

2.2.2 “⏵” :short press to adjust the temperature value / long press to manually clean the condenser.

2.2.3 “SET” :short press to enter temperature setting adjustment / long press to enter internal setting.

2.2.4 “❄️” :short press to turn on / off LED light / long press to defrost manually.

2.3. Operation instruction

2.3.1 Adjustment of temperature setting value(the buzzer will beep once every effective button is pressed, the same below)

2.3.1 Under power-on state, press “SET” to enter the temperature setting state, and the temperature display area flashes the set temperature value. Press “⏵” or “⏴” to increase or decrease the temperature setting value by 1°C .

2.3.2 Temperature setting range: within the range of internal parameters E1~E2; Factory default value: 2°C .

2.3.3 If press the button without a key for more than 10 seconds or press the “SET” button again within 10 seconds, it will exit the temperature setting state and return to the normal display, and the setting value will be saved in the battery-free memory.

2.4 LED light operation

2.4.1 Under normal startup state and the light is on, short press “❄️” light, and the LED light will go off; Press the “❄️” light again, and the LED light will light up.

2.5 Lock / unlock operation

2.5.1 Under the power on state and unlocked state, long press “⏴” button, and after 10 seconds the temperature area flashes “OFF” , indicating that internal settings are locked and internal parameters are forbidden to be modified. After 10 seconds of display, it will return to normal display state and save in battery-free memory body;

2.5.2 If the internal parameter item is locked, long press “⏴” button, and the display screen will display “ON” after 10 seconds, indicating unlocking. After 10 seconds, the display will return to the normal display state and save it in battery-free memory body.

2.6 Condenser cleaning operation

2.6.1 Under normal working condition, long press “⏵” key to start condenser cleaning after 6 seconds, and long press “⏵” key again under cleaning condition to stop cleaning after 6 seconds.

2.6.2 Cleaning time: 30 seconds

2.6.3 Cleaning interval frequency: press F7 setting item, range: 1~15 days.

2.6.4 When the cleaning starts, the leftmost point of the display flashes, indicating that the cleaning work is in progress.

2.6.5 The current cleaning interval will be saved in battery-free memory every hour/once.

2.7 Manual defrosting operation

2.7.1 Under normal working condition, press the “❄️” key for a long time and enter manual defrosting after 6 seconds. (defrosting function refers to defrosting function instruction).

2.8 Internal parameter adjustment

2.8.1 Under normal power on state, long press the “SET” key and hold on for 6 seconds, then enter the internal setting item, and the first parameter “E1” will be displayed in the temperature area. If the key is locked, the internal parameter item can only be browsed without changing the internal setting value.

2.8.2 Internal parameter table

Character	Name	Range	Factory Default
E1	Minimum temperature adjustable value (set.T)	-30°C ~set.T -22°F ~set.T	2°C 35°F
E2	Maximum temperature adjustable value (set.H)	set.T~49°C set.T~120°F	6°C 42°F
E3	Temperature control return value	1~10°C 1~16°F	4°C 7°F
E4	Delayed start-up time of compressor	0~10MIN	3MIN
E5	Temperature probe correction	-5~5°C -9~9°F	0°C
E6	Defrosting probe calibration	-5~5°C -9~9°F	0°C
F1	Defrosting time	1~60MIN	25MIN
F2	Defrosting cycle	0~24H	4H
F3	Defrosting termination temperature	0~20°C 32~68°F	15°C 59°F
F4	Defrosting termination temperature	00-normal display of reservoir temperature 01-temperature at the beginning of defrosting	00
F7	Condenser cleaning interval	01~15Days	2Days
C1	Temperature unit display	00-°C 01-°F	00